

OMRON

High-resolution Digital Proximity Sensor **with Separate Amplifier**
E2C-EDA Series



A Digital Proximity Sensor At Last!



realizing

Finally a Digital Proximity Sensor Capable of High-resolution Sensing with Unprecedented Ease

Sensors

■ An Impressive Lineup of Sensor Heads to Handle a Wide Variety of Applications

An Array of Heads

The lineup includes some Sensor Heads as thin as 3-mm in diameter and others that are thin and flat. Narrow installation spaces are not a problem for these models. Still other Sensor Heads are heat resistant or rated IP67 for superior environmental resistance. These models are capable of high-resolution sensing even in harsh environments.



Flexible Cables Provided as a Standard Feature

Industry First

With flexible cables connecting the Preamplifier to the Amplifier, installation on moving parts is never a problem. The twin-output models can also output an open-circuit alarm. In that rare instance where the cable breaks, the E2C-EDA can then send out an alarm that greatly simplifies the task of locating the faulty Sensor.

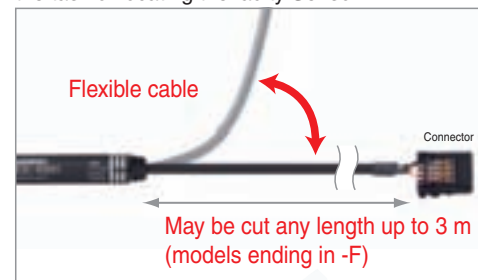

■ High-resolution Sensing Unaffected by Environmental Swings

Industry Leader

Excellent temperature characteristics at 0.08%/°C (5.4-mm dia. Sensor Head)

In addition to repeat accuracy of 1- μ m or better, the temperature characteristics of the E2C-EDA are flat. This means that environmental factors, such as temperature swings in the morning and at night, will not affect high-resolution positioning and screening.

■ Temperature Influence (Typical Examples)
5.4-mm dia. E2C-ED01(-E)

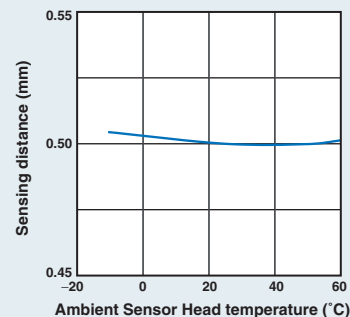

Amplifiers

Simple and Reliable Measurements with Micron-level Resolution Industry First

Two Clear, Large, and Easy-to-Read Digital Displays
The E2C-EDA features two large, easy-to-read digital displays. Since the digitized detected and threshold values can be checked at the same time, settings are simple and reliable for just about anyone. Various teaching methods are also available for settings that cannot be made consistently by different operators.

Digital Display Simplifies Installation and Settings
In the stable sensing zone, the E2C-EDA generally reads 1,500 or higher (see note 2). This way you can tell at a glance whether the current installation and settings are within the optimal range.

Note 2: This reading is only a guideline because there may be some variation between Sensors. Also refer to the *Engineering Data* because values may vary with non-standard objects.

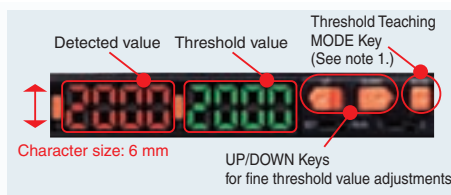

Note 1: Press the MODE Key with the E3C-EDA running to switch to individual teaching modes, Fine Positioning, or Zero Reset.

Connector for Connecting Sensor Heads to Amplifiers

A Shielded Connector is used for more reliable wiring and easier cable handling. Since the press-fit connector allows repeat connections, wiring and head replacement are simple and reliable.

Support for High-resolution Positioning and Screening Patent pending

Fine Positioning Maximizes Digital Changes

Fine Positioning maximizes changes in the digital value as you get closer to the sensing point. More precise sensing can be achieved by executing Fine Positioning with the workpiece positioned at the point to be maximized.

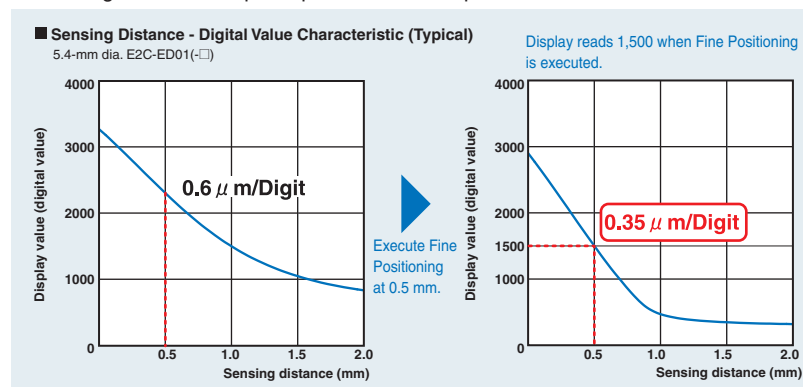

Smart Functions for High-resolution Parts and Assembly Inspection Applications

Applications

Screening

Mixed bearing inspection
(material and height sensing)

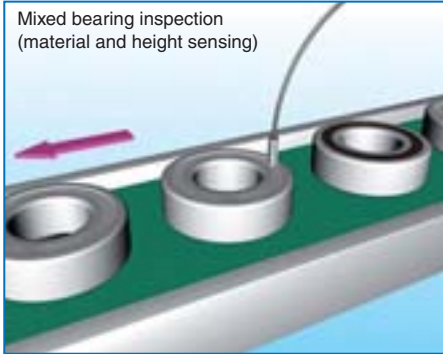

Digital Display

The E2C-EDA can visually recognize height and material differences simply and reliably even with the most demanding settings.

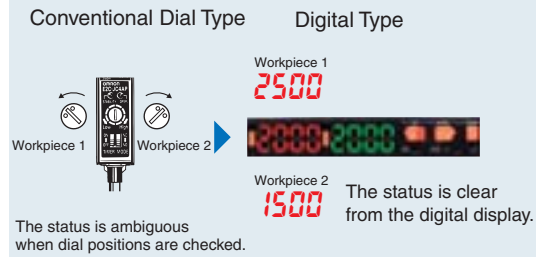

Height inspection

Capacitor sleeve
mounting inspection



Area Output (Twin-output Type)

An OK/NG result is easily obtained because the E2C-EDA outputs a signal between two threshold values.

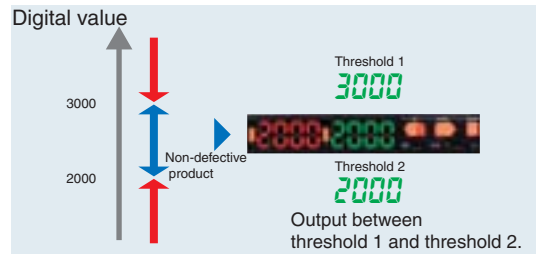

Height inspection

Screw assembly
inspection

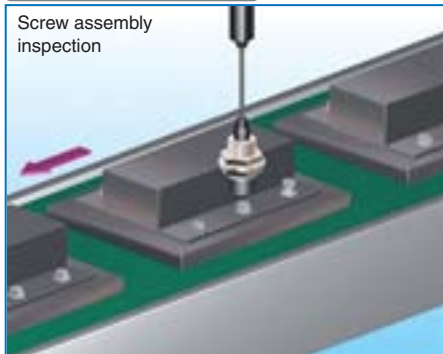

Mutual Interference Prevention

The E2C-EDA has a mutual interference prevention function that uses intermittent sensing via optical communications to enable up to 5 Sensors to be combined very closely together. This feature enables multiple measurements to be made in a machine or process.

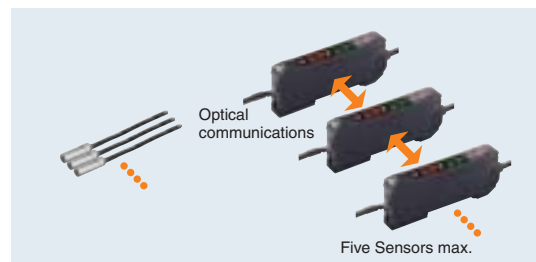

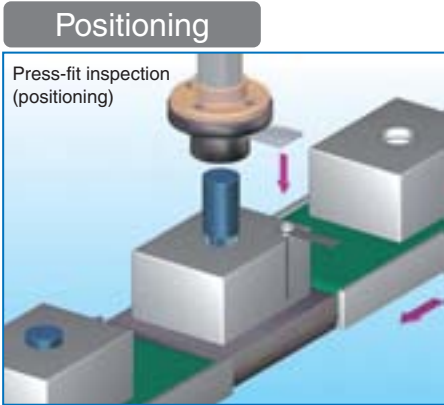

Teaching

Position teaching yields consistent settings that cannot be matched by operator settings.

| Conventional dial type | Digital type |
|---|---|
| <p>Operator setting inconsistencies</p> | <p>Perfect</p> <p>Settings are simple enough for anyone with teaching (reduces operator setting inconsistencies).</p> |

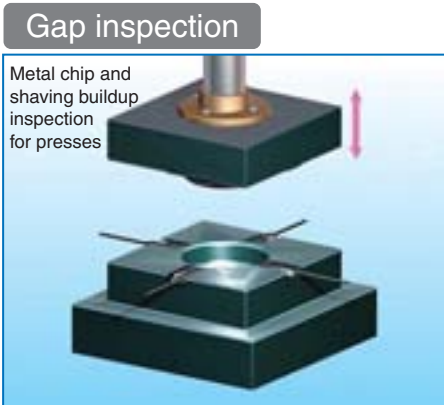

Zero Reset (Fixed Threshold)

When using a fixed sensing gap (threshold), the origin and reference position can be corrected quite simply if needed, such as when changing the process being performed.

| Change in Machine Arrangement | |
|-------------------------------|-----------------------------------|
| | The origin (reference) is offset. |
| | |
| | Correction completed! |

■ **Simple and Common Sensor Operation in Devices**

Platform Concept Ensures Common Operation and Programming Devices



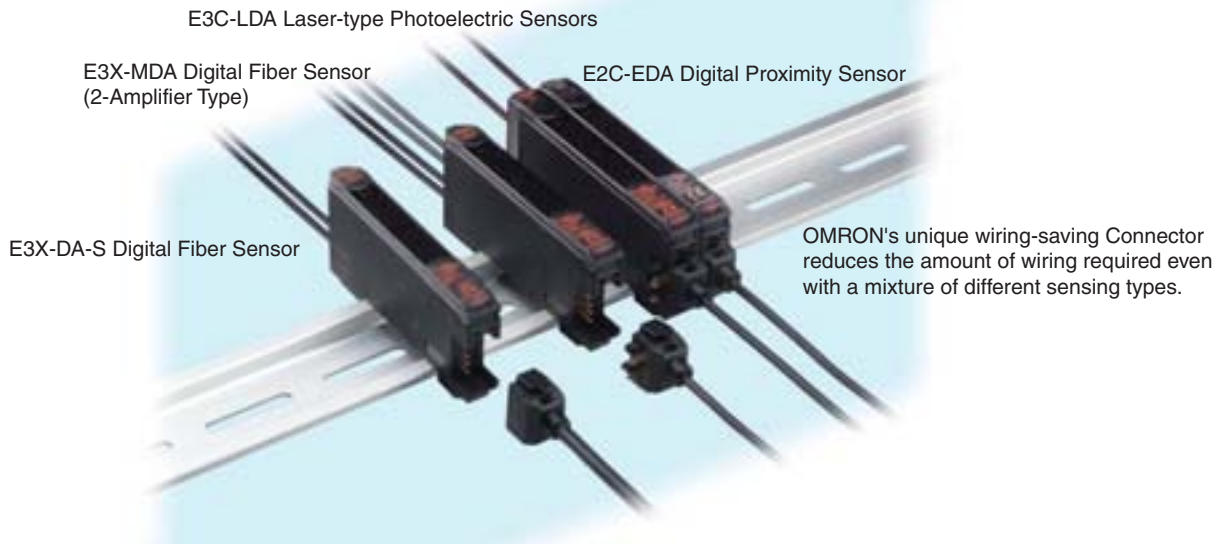

The basic functions and Programming Devices like the Mobile Console are the same for the E2C-EDA as they are for the E3X-DA-S Digital Fiber Sensor and the E3C-LDA Laser-type Photoelectric Sensor. Just select the right type of E2C-EDA for the application, and the rest is easy.



Ordering Information

■ Sensors

Sensor Heads

| Type | Appearance | Sensing distance | Repeat accuracy | Model | |
|----------------|--|------------------|-----------------|-------|--------------------------------------|
| Shielded |  Cylindrical | 3 dia. × 18 mm | 0.6 mm | 1 μm | E2C-EDR6-F (See note 2.) |
| | | 5.4 dia. × 18 mm | 1 mm | 1 μm | E2C-ED01-□ (See notes 1, 2, and 3.) |
| | | 8 dia. × 22 mm | 2 mm | 2 μm | E2C-ED02-□ (See notes 1, 2, and 3.) |
| |  Screw | M10 × 22 mm | 2 mm | 2 μm | E2C-EM02-□ (See notes 1, 2, and 3.) |
| |  Flat | 30 × 14 × 4.8 mm | 5 mm | 2 μm | E2C-EV05-□ (See notes 1, 2, and 3.) |
| Unshielded |  Screw | M18 × 46.3 mm | 7 mm | 5 μm | E2C-EM07M-□ (See notes 1, 2, and 3.) |
| Heat-resistant |  Screw | M12 × 22 mm | 2 mm | 2 μm | E2C-EM02H (See note 2.) |

Note 1. A Protective Spiral Tube is provided with models ending in the suffix -S. (example: E2C-ED01-S).

2. Two cable lengths are available. (3-dia.: free-cut type, Heat-resistant type: standard-length only).

Overall length of the standard-length type: 2.5 m, Length from the Sensor Head to the Preamplifier: 2.0 m (Example: E2C-ED01)

Overall length of the free-cut type: 3.5 m, Length from the Sensor Head to the Preamplifier: 0.5 m for models ending in the suffix -F (example: E2C-ED01F).

3. Models ending in the suffix -S that come with Protective Spiral Tubes and free-cut models ending in the suffix -F are made-to-order products.

Amplifier Units

Amplifier Units with Cables

| Item | | Appearance | Functions | Model | |
|-----------------|-----------------------|---|---|------------|------------|
| | | | | NPN output | PNP output |
| Advanced models | Twin-output models |  | Area output, open circuit detection, differential operation | E2C-EDA11 | E2C-EDA41 |
| | External-input models | | Remote setting, differential operation | E2C-EDA21 | E2C-EDA51 |

Amplifier Units with Connectors

| Item | | Appearance | Functions | Model | |
|-----------------|-----------------------|---|---|------------|------------|
| | | | | NPN output | PNP output |
| Advanced models | Twin-output models |  | Area output, open circuit detection, differential operation | E2C-EDA6 | E2C-EDA8 |
| | External-input models | | | E2C-EDA7 | E2C-EDA9 |

Amplifier Unit Connectors (Order Separately)

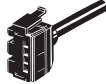
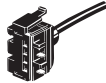
| Item | Appearance | Cable length | No. of conductors | Model |
|------------------|---|--------------|-------------------|----------|
| Master Connector |  | 2 m | 4 | E3X-CN21 |
| Slave Connector |  | | 2 | E3X-CN22 |

Connector Ordering Precaution





Amplifier Units and Connectors are sold separately.
Refer to the following tables when placing an order.

| Amplifier Unit | | | Applicable Connector (Order Separately) | |
|-----------------|------------|------------|---|-----------------|
| Model | NPN output | PNP output | Master Connector | Slave Connector |
| Advanced models | E2C-EDA6 | E2C-EDA8 | E3X-CN21 | E3X-CN22 |
| | E2C-EDA7 | E2C-EDA9 | | |

When Using 5 Amplifier Units

| | | | |
|---------------------------|---|--------------------|--------------------|
| Amplifier Units (5 Units) | + | 1 Master Connector | 4 Slave Connectors |
|---------------------------|---|--------------------|--------------------|

Mobile Console (Order Separately)

| Appearance | Model | Remarks |
|---|---------------------------------------|---|
|  | E3X-MC11-SV2 (model number of set) | Mobile Console with Head, Cable, and AC adapter provided as accessories |
|  | E3X-MC11-C1-SV2 | Mobile Console |
|  | E3X-MC11-H1 | Head |
|  | E39-Z12-1 | Cable (1.5 m) |

Note: Use the E3X-MC11-SV2 Mobile Console with E2C-EDA-series Amplifier Units. If you use a Mobile Console like the E3X-MC11-S, some functions may not operate.

Accessories (Order Separately)

Mounting Bracket

| Appearance | Model | Quantity |
|---|----------|----------|
|  | E39-L143 | 1 |

End Plate

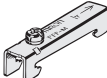
| Appearance | Model | Quantity |
|---|-------|----------|
|  | PFP-M | 1 |

Specifications

Sensor Heads

| Model | | E2C-EDR6-F | E2C-ED01(-□) | E2C-ED02(-□) | E2C-EM02(-□) | E2C-EM07(-□) | E2C-EV05(-□) | E2C-EM02H | |
|--|----------------------------|--|---|-----------------|---------------------|----------------|------------------|------------------------------|------|
| Item | | 3 dia. × 18 mm | 5.4 dia. × 18 mm | 8 dia. × 22 mm | M10 × 22 mm | M18 × 46.3 mm | 30 × 14 × 4.8 mm | M12 × 22 mm | |
| Sensing distance | | 0.6 mm | 1 mm | 2 mm | | 7 mm | 5 mm | 2 mm | |
| Sensing object | | Magnetic metal (The sensing distance will decrease when sensing non-magnetic metal. Refer to <i>Engineering Data</i> on page 10.) | | | | | | | |
| Standard sensing object | | 5 × 5 × 3 mm | | 10 × 10 × 3 mm | | 22 × 22 × 3 mm | 15 × 15 × 3 mm | 20 × 20 × 3 mm | |
| | | Material: iron (S50C) | | | | | | | |
| Repeat accuracy (See note 1.) | | 1 μm | | 2 μm | | 5 μm | 2 μm | | |
| Hysteresis distance | | Variable | | | | | | | |
| Temperature characteristic (See note 1.) | Sensor Head | 0.3%/°C | 0.08%/°C | | | | 0.04%/°C | 0.2%/°C | |
| | Preamplifier and Amplifier | 0.08%/°C | | | | | | | |
| Ambient temperature (See note 2.) | Operating | -10°C to 60°C (with no icing or condensation) | | | | | | -10°C to 200°C (See note 3.) | |
| | Storage | -10°C to 60°C (with no icing or condensation) | -20°C to 70°C (with no icing or condensation) | | | | | | |
| Ambient humidity | | Operating/storage: 35% to 85% (with no condensation) | | | | | | | |
| Insulation resistance | | 50 MΩ min. (at 500 VDC) | | | | | | | |
| Dielectric strength | | 1,000 VAC at 50/60 Hz for 1 min between current carry parts and case | | | | | | | |
| Vibration resistance | | Destruction: 10 to 55 Hz, 1.5-mm double amplitude for 2 hours each in X, Y, and Z directions | | | | | | | |
| Shock resistance | | Destruction: 500 m/s ² for 3 times each in X, Y, and Z directions | | | | | | | |
| Degree of protection | | IEC60529 IP67 | | | | | | IEC60529 IP60 (See note 4.) | |
| Connection method | | Connector (standard cable length: 2.5 m (2 m between Head and Preamplifier) "F" model cable length: 3.5 m (0.5 m between Head and Preamplifier) | | | | | | | |
| Weight (packed state) | | Approx. 120 g (Models with protective spiral tube ("S" models) are approx. 90 g heavier.) | | | | | | | |
| Material | Sensor Head | Case | Brass | Stainless steel | Brass | | Zinc | Brass | |
| | | Sensing surface | Heat-resistant ABS | | | | | | PEEK |
| | Clamping nut | --- | | | Nickel-plated brass | | --- | Nickel-plated brass | |
| | Toothed washer | --- | | | Zinc-plated iron | | --- | Zinc-plated iron | |
| | Preamplifier | PES | | | | | | | |
| Accessories | | Preamplifier Mounting Brackets, Instruction Manual | | | | | | | |

Note 1. The repeat accuracy and temperature characteristic are for a standard sensing object positioned midway through the rated sensing distance.

2. A sudden temperature rise even within the rated temperature range may degrade characteristics.

3. For the Sensor Head only without the preamplifier (-10 to 60°C). With no icing or condensation.

4. Do not operate in areas exposed to water vapor because the enclosure is not waterproof.

Amplifier Units

| Item | Type | | Advanced Models with Twin Outputs | | Advanced Models with External Inputs | |
|------------------------------|---------------------------------------|--|---|--|--------------------------------------|--------------|
| | Model | NPN output | E2C-EDA11 | E2C-EDA6 | E2C-EDA21 | E2C-EDA7 |
| | | PNP output | E2C-EDA41 | E2C-EDA8 | E2C-EDA51 | E2C-EDA9 |
| Supply voltage | | | 12 to 24 VDC ±10%, ripple (p-p): 10% max. | | | |
| Power consumption | | | 1,080 mW max. (current consumption: 45 mA at power supply voltage of 24 VDC) | | | |
| Control output | | | Load power supply voltage: 26.4 VDC max.; NPN/PNP open collector output; load current: 50 mA max. (residual voltage: 1 V max.) | | | |
| Response time | Super-high-speed mode | | 150 μs for operation and reset respectively | | | |
| | High-speed mode | | 300 μs for operation and reset respectively | | | |
| | Standard mode | | 1 ms for operation and reset respectively | | | |
| | High-resolution mode | | 4 ms for operation and reset respectively | | | |
| Functions | Differential detection | | Switchable between single edge and double edge detection mode Single edge: Can be set to 300 μs, 500 μs, 1 ms, 10 ms, or 100 ms Double edge: Can be set to 500 μs, 1 ms, 2 ms, 20 ms, or 200 ms. | | | |
| | Timer function | | Select from OFF-delay, ON-delay, or one-shot timer. 1 ms to 5 s (1 to 20 ms set in 1-ms increments, 20 to 200 ms set in 10-ms increments, 200 ms to 1 s set in 100-ms increments, and 1 to 5 s set in 1 s-increments) | | | |
| | Zero-reset | | Negative values can be displayed. (Threshold is not shifted.) | | | |
| | Initial reset | | Settings can be returned to defaults as required. | | | |
| | Mutual interference prevention | | Possible for up to 5 Units. (See note.) Intermittent oscillation method (Response time = (number of Units connected + 1) × 15 ms) | | | |
| | Hysteresis settings | | Setting range: 10 to 4,000 | | | |
| I/O settings | | Output setting (Select from channel 2 output, area output, self-diagnosis, or open circuit detection.) | | Input setting (Select from teaching, fine positioning, zero-reset, synchronous detection.) | | |
| Digital display | | | Select from the following: Incident level + threshold, incident level percentage +threshold, incident light peak level + incident light bottom level (updated with output), long bar display, incident level + peak hold, incident level + channel | | | |
| Display orientation | | | Switching between normal/reversed display is possible. | | | |
| Ambient temperature | | | Operating: When connecting 1 to 2 Units: -10°C to 55°C When connecting 3 to 5 Units: -10°C to 50°C When connecting 6 to 16 Units: -10°C to 45°C When used in combination with an EDR6-F When connecting 3 to 4 Units: -10°C to 50°C When connecting 5 to 8 Units: -10°C to 45°C When connecting 9 to 16 Units: -10°C to 40°C Storage: -20°C to 70°C (with no icing) | | | |
| Ambient humidity | | | Operating/storage: 35% to 85% (with no condensation) | | | |
| Insulation resistance | | | 20 MΩ min. (at 500 VDC) | | | |
| Dielectric strength | | | 1,000 VAC at 50/60 Hz for 1 min | | | |
| Vibration resistance | | | Destruction: 10 to 55 Hz, 1.5-mm double amplitude for 2 hours each in X, Y, and Z directions | | | |
| Shock resistance | | | Destruction: 500 m/s ² for 3 times each in X, Y, and Z directions | | | |
| Degree of protection | | | IEC60529 IP50 | | | |
| Connection method | | | Prewired | Connector | Prewired | Connector |
| Weight (packed state) | | | Approx. 100 g | Approx. 55 g | Approx. 100 g | Approx. 55 g |
| Material | Case | | PBT (polybutylene terephthalate) | | | |
| | Cover | | Polycarbonate | | | |

Note: Communications are disabled if the detection mode is selected during super-high-speed sensing mode, and the communications functions for mutual interference prevention and the Mobile Console will not function.

Engineering Data

Sensing Distance vs. Display Values

E2C-EDR6-F

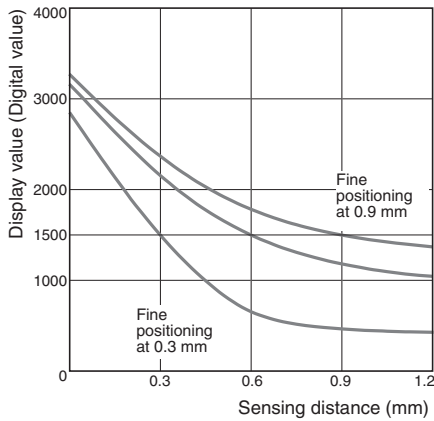

E2C-ED01(-□)

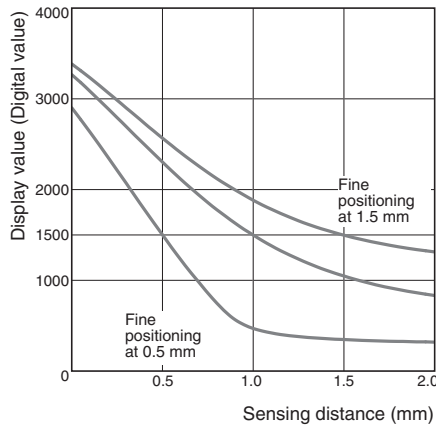

E2C-ED02(-□)/EM02(-□)

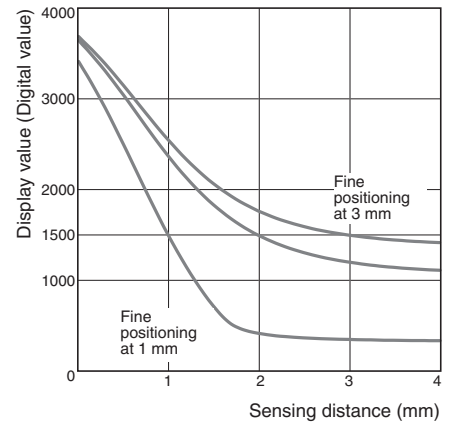

E2C-EM07(-□)

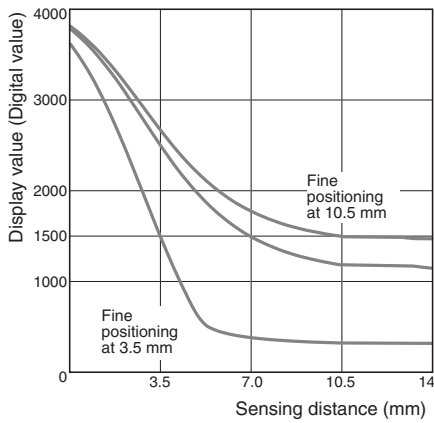

E2C-EV05(-□)

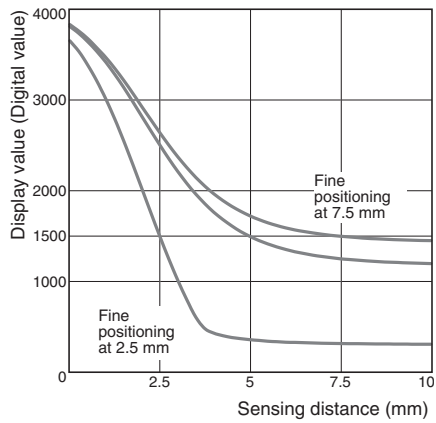

E2C-EM02H

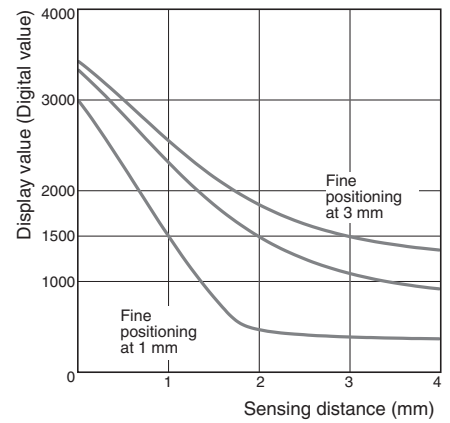

Influence of Sensing Object Size and Material

E2C-EDR6-F

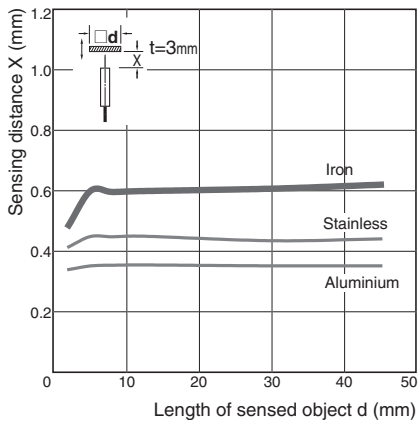

E2C-ED01(-□)

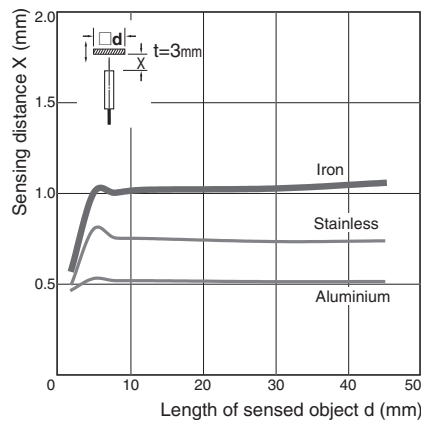

E2C-ED02(-□)/EM02(-□)

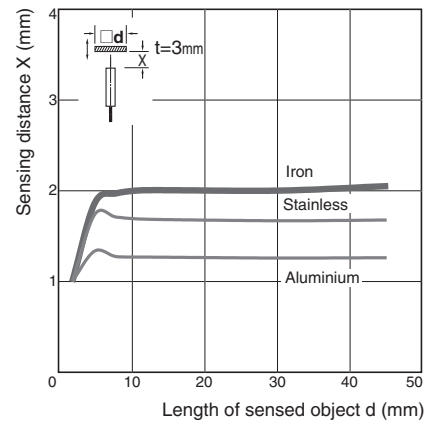

E2C-EM07(-□)

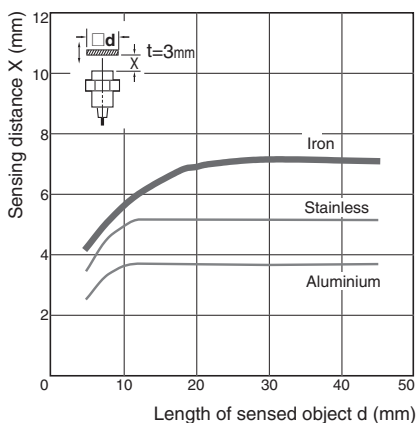

E2C-EV05(-□)

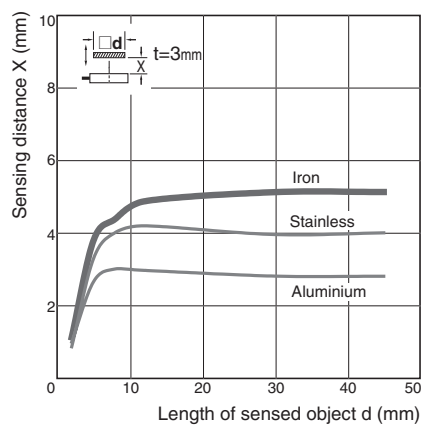

E2C-EM02H

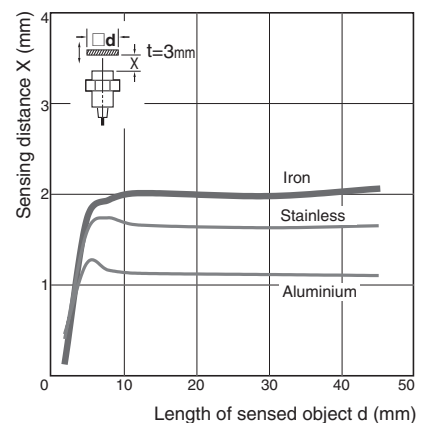

Influence of Sensor Head Temperature

E2C-EDR6-F

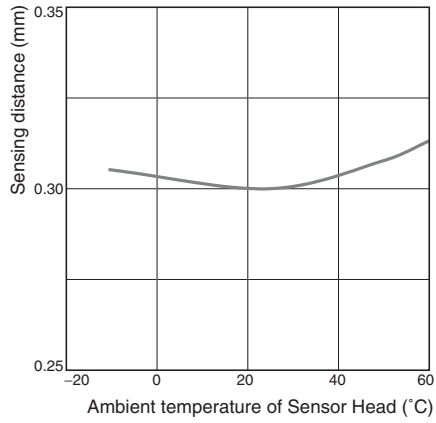

E2C-ED01(-□)

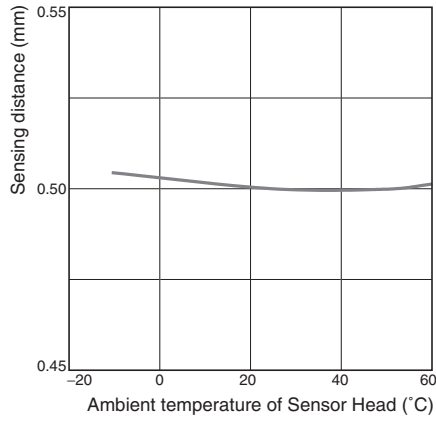

E2C-ED02(-□)/EM02(-□)

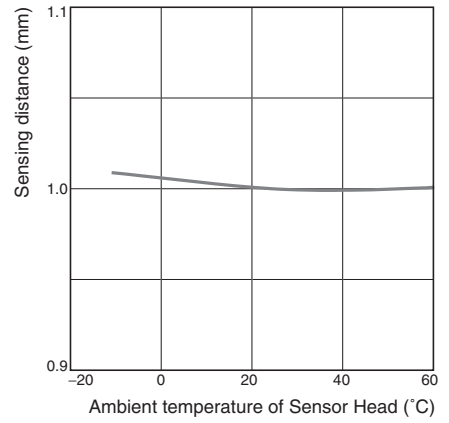

E2C-EM07(-□)

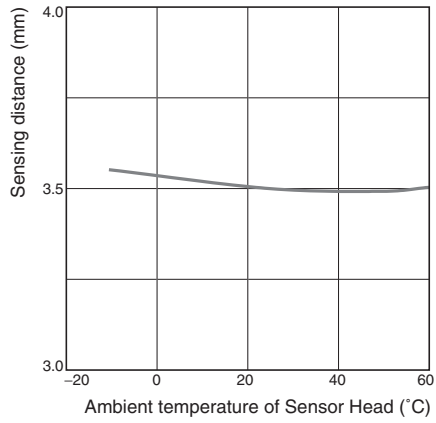

E2C-EV05(-□)

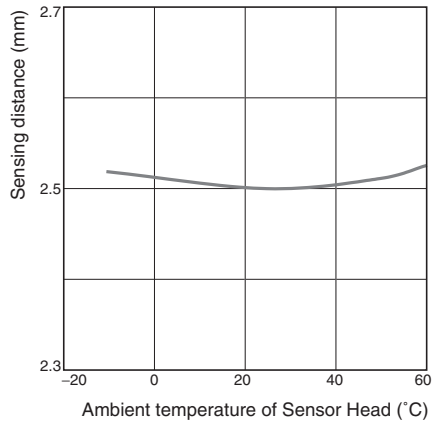

E2C-EM02H

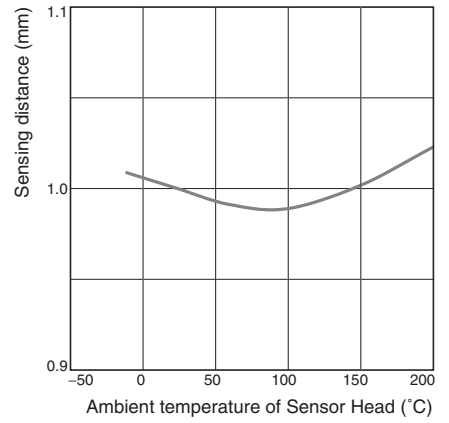

Operation

NPN Output

| Model | Operation mode | Timing chart | Mode selector | Output circuit |
|-----------------------|----------------------|--------------|---------------|----------------|
| E2C-EDA11 E2C-EDA6 | NO (Normally open) | | NO | |
| | NC (Normally closed) | | NC | |
| E2C-EDA21 E2C-EDA7 | NO (Normally open) | | NO | |
| | NC (Normally closed) | | NC | |

Note 1. Setting Areas for Twin-output Models

- Normally open: ON between the thresholds for Channel 1 and Channel 2
- Normally closed: OFF between the thresholds for Channel 1 and Channel 2

2. Timing Charts for Timer Settings (T: Set Time)

| ON delay | OFF delay | One shot |
|----------|-----------|----------|
| | | |

PNP Output

| Model | Operation mode | Timing chart | Mode selector | Output circuit |
|-----------------------|----------------------|--|---------------|----------------|
| E2C-EDA41 E2C-EDA8 | NO (Normally open) | Sensing object: Yes (ON), No (OFF) Operation indicator (orange): Lit (ON), Not lit (OFF) Output transistor: ON (ON), OFF (OFF) Load (relay, etc.): Operate (ON), Reset (OFF) (Between blue and black lines) | NO | |
| | NC (Normally closed) | Sensing object: Yes (ON), No (OFF) Operation indicator (orange): Lit (ON), Not lit (OFF) Output transistor: ON (ON), OFF (OFF) Load (relay, etc.): Operate (ON), Reset (OFF) (Between blue and black lines) | NC | |
| E2C-EDA51 E2C-EDA9 | NO (Normally open) | Sensing object: Yes (ON), No (OFF) Operation indicator (orange): Lit (ON), Not lit (OFF) Output transistor: ON (ON), OFF (OFF) Load (relay, etc.): Operate (ON), Reset (OFF) (Between blue and black lines) | NO | |
| | NC (Normally closed) | Sensing object: Yes (ON), No (OFF) Operation indicator (orange): Lit (ON), Not lit (OFF) Output transistor: ON (ON), OFF (OFF) Load (relay, etc.): Operate (ON), Reset (OFF) (Between blue and black lines) | NC | |

Note 1. Setting Areas for Twin-output Models

Normally open: ON between the thresholds for Channel 1 and Channel 2
 Normally closed: OFF between the thresholds for Channel 1 and Channel 2

2. Timing Charts for Timer Settings (T: Set Time)

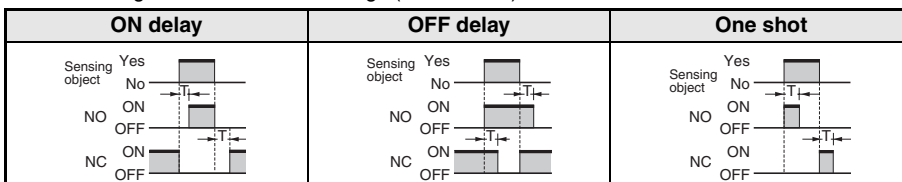

Nomenclature

Amplifier Units

Twin-output Models

(E2C-EDA11/EDA41/EDA6/EDA8)

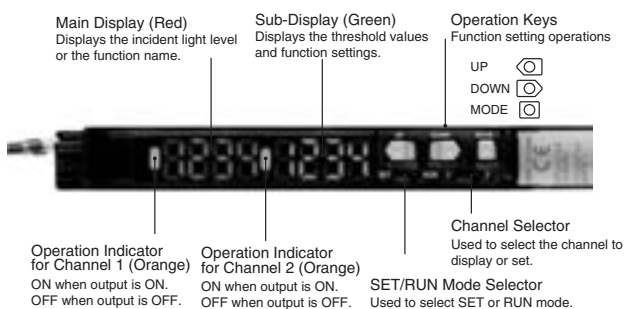

External-input Models

(E2C-EDA21/EDA51/EDA7/EDA9)

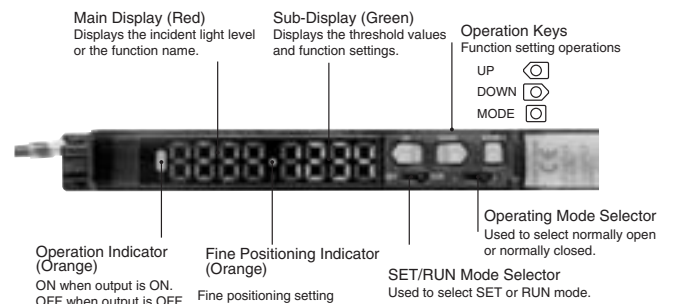

Precautions

⚠ WARNING

Do not use this product in any safety device used for the protection of human lives.



Precautions for Correct Use

Do not use this product in operating atmospheres or environments outside the specified ratings.

Amplifier Units

● Design

Power ON

The Sensor is ready to sense an object within 200 ms after turning the power ON. If the load and Sensor are connected to different power supplies, always turn ON the Sensor power first.

● Connecting Sensor Heads

Connecting and Disconnecting Sensor Heads

1. Open the protective cover.
2. Making sure that the lock button is up, insert the fibers all the way to the back of the Connector insertion opening.

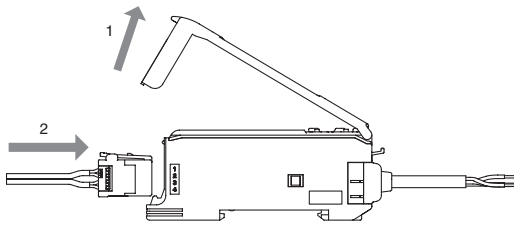

To disconnect the Sensor Head, pull out the fibers while pressing on the lock button.

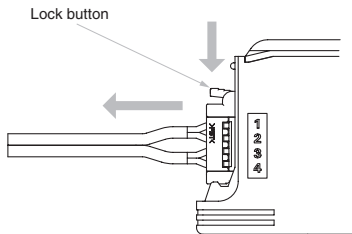

Connecting and Disconnecting Connectors

Connecting Connectors

1. Insert the Master or Slave Connector into the Amplifier Unit until it clicks into place.

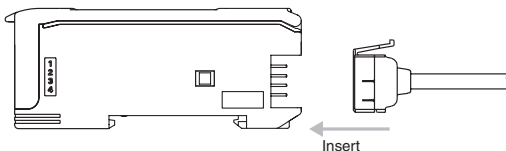

2. Apply the supplied seal to the non-connection surface of the Master/Slave Connector.

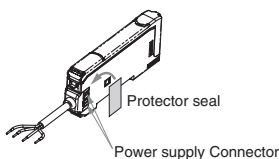

Note: Apply the seal to the grooved side.

Disconnecting Connectors

1. Slide the Slave Amplifier Unit.
2. After the Amplifier Unit has been separated, press down on the lever on the Connector and remove it. (Do not attempt to remove Connectors without separating them from other Amplifier Units first.)

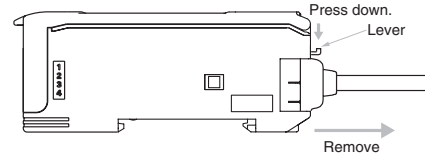

Installing and Removing Amplifier Units

Installing Amplifier Units

1. Install the Units one by one to the DIN rail.

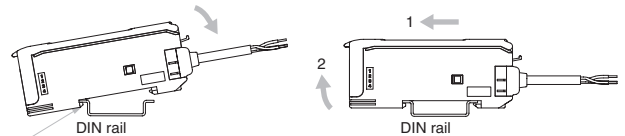

Sensor Head Connector Clips

2. Slide one Unit toward the other, match the clips at the front ends, and then bring them together until they “click.”

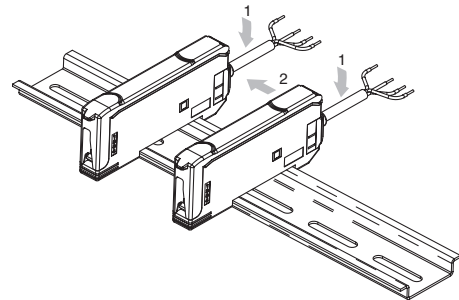

Removing Amplifier Units

Slide one Unit away from the other and remove them one by one. (Do not remove the connected Units together from the DIN rail.)

Note 1. When the Amplifier Units are connected to each other, the operable ambient temperature changes depending on the number of connected Amplifier Units. Check Specifications.
2. Before connecting or disconnecting the Units, always switch power OFF.

End Plate Mounting (PFP-M)

Mount End Plates on Amplifier Units to avoid movement due to vibration. When a Mobile Console is installed, mount the End Plate facing as shown in the following diagram.

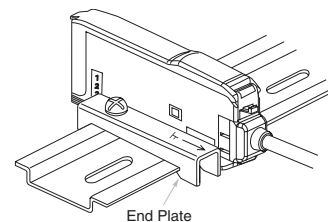

Mounting a Communications Head for the Mobile Console

Leave a space of at least 20 mm on the left side of the Units for a Mobile Console Communications Head.

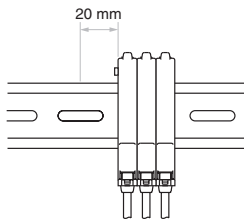

EEPROM Write Error

If the data is not written to the EEPROM correctly due to a power failure or static-electric noise, initialize the settings using the keys on the Amplifier Unit.

Optical Communications

When using more than one Amplifier Unit, mount the Units side-by-side. Do not slide or remove Units while they are in use.

Miscellaneous

Protective Cover

Be sure to put on the Protective Cover before use.

Mobile Console

Use the E3X-MC11-SV2 Mobile Console for E2C-EDA-series Amplifier Units. Other Mobile Consoles, such as the E3X-MC11, cannot be used.

Sensor Head and Amplifier Unit Connection

Be sure to use only specified Sensor Head and Amplifier Unit combinations. The E3C-LDA-series Photoelectric Sensor with Separate Digital Amplifier is not compatible, and the E2C-EDA must not be used with products from that series.

Warm-up

The digital display will slowly change until the circuits stabilize after the power is turned ON. It takes about 30 minutes after the power is turned ON before the E2C-EDA is ready to sense.

Maintenance Inspection

- Be sure to turn OFF the power before adjusting, connecting, or disconnecting the Sensor Head.
- Do not use thinner, benzene, acetone, or kerosene to clean the Sensor Head or Amplifier Unit.

Sensor Heads

Mounting

Mounting Sensor Heads

- Use the dimensions from the following table to mount unthreaded cylindrical models (E2C-ED-□□). Do not tighten screws with torque exceeding 0.2 N·m when mounting Sensor Heads.

| Model | Tightening range A |
|------------|--------------------|
| E2C-EDR6-F | 9 to 18 mm |
| E2C-ED01□□ | 9 to 18 mm |
| E2C-ED02□□ | 11 to 12 mm |

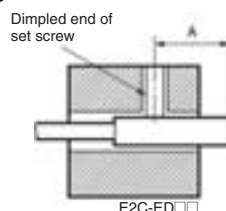

- Use the torque given in the following table to tighten threaded cylindrical models (E2C-EM□□).

| Model | Tightening torque |
|-------------|-------------------|
| E2C-EM02□□ | 15 N·m max. |
| E2C-EM07M□□ | 15 N·m max. |
| E2C-EM02H□□ | 5.9 N·m max. |

- Do not use torque exceeding 0.5 N·m to tighten screws when mounting flat models (E2C-EV□□).
- Use a bending radius of at least 8 mm for the Sensor Head cable.
- Use only the special extension cable to extend the cable between the Sensor Head and the Amplifier Unit. Consult your OMRON representative for details.

Effects of Surrounding Metal

- Provide a minimum distance between the Sensor and the surrounding metal as shown in the table below.

Effects of Surrounding Metal (Units: mm)

| Model | Counterbore A | Protrusion B |
|-------------|---------------|--------------|
| E2C-EDR6-F | 3.1 | 0 |
| E2C-ED01□□ | 5.4 | 0 |
| E2C-ED02□□ | 8 | 0 |
| E2C-EM02□□ | 10 | 0 |
| E2C-EM07M□□ | 35 | 20 |
| E2C-EV05□□ | 14 × 30 | 4.8 |
| E2C-EM02H□□ | 12 | 0 |

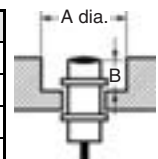

Mutual Interference

- If more than one Sensor Head is installed face to face or in parallel, make sure that the distances between two Units adjacent to each other are the same as or larger than the corresponding values shown in the following table.
- The distance between Sensor Heads may be narrower than specified with these Sensors because the Mutual Interference Prevention Function is used for optical communications between the Amplifier Units.

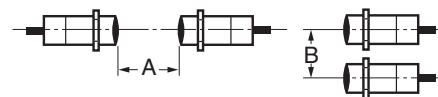

Mutual Interference (Units: mm)

| Model | Face-to-face arrangement A | Parallel arrangement B | Face-to-face arrangement using the Mutual Interference Prevention Function A' | Parallel arrangement using the Mutual Interference Prevention Function B' |
|-------------|----------------------------|------------------------|---|---|
| E2C-EDR6-F | 14 | 10 | 3.5 | 3.1 |
| E2C-ED01□□ | 45 | 20 | 9 | 5.4 |
| E2C-ED02□□ | 35 | 30 | 21 | 8 |
| E2C-EM02□□ | 36 | 30 | 21 | 10 |
| E2C-EM07M□□ | 140 | 120 | 35 | 18 |
| E2C-EV05□□ | 65 | 30 | 21 | 14 |
| E2C-EM02H□□ | 45 | 30 | 21 | 12 |

Dimensions

Sensors

E2C-EDR6-F

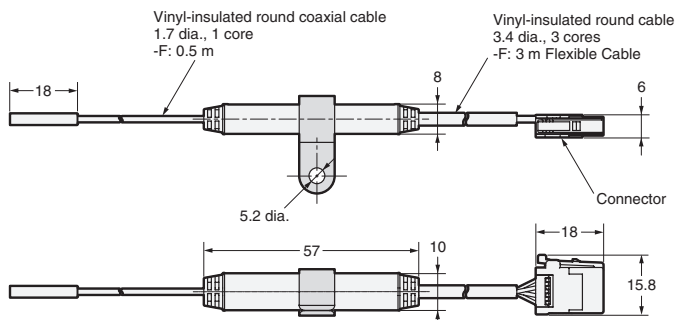
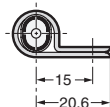

E2C-ED01(-F)

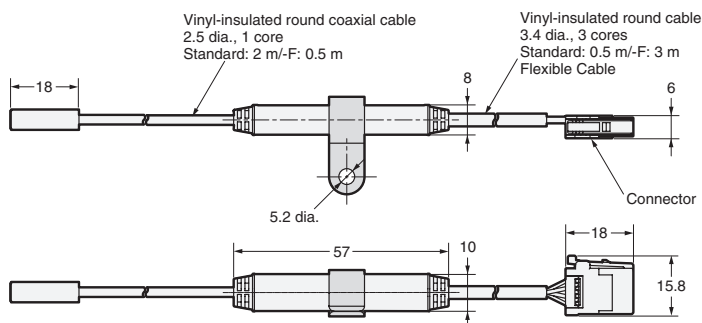
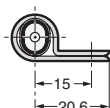

E2C-ED02(-F)

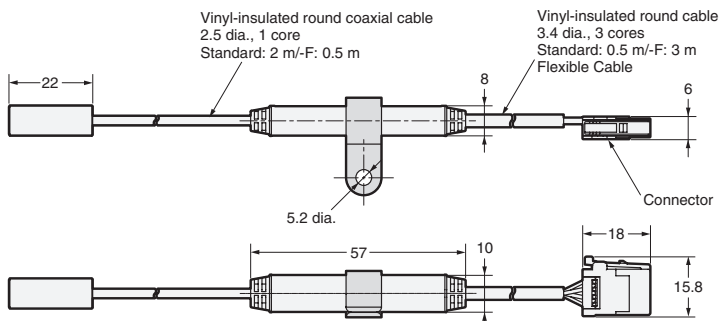
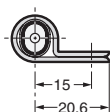

E2C-EM02(-F)

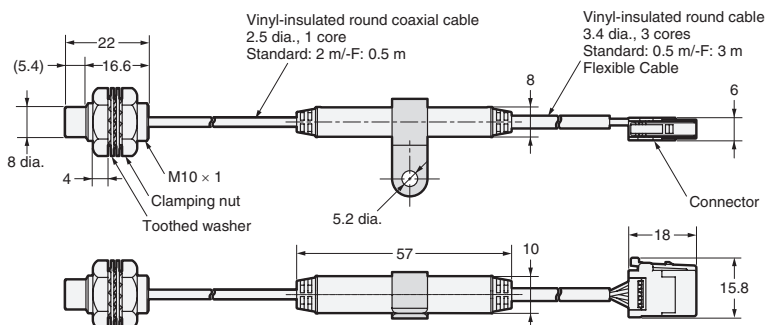
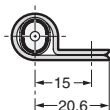
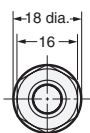

E2C-EM07M(-F)

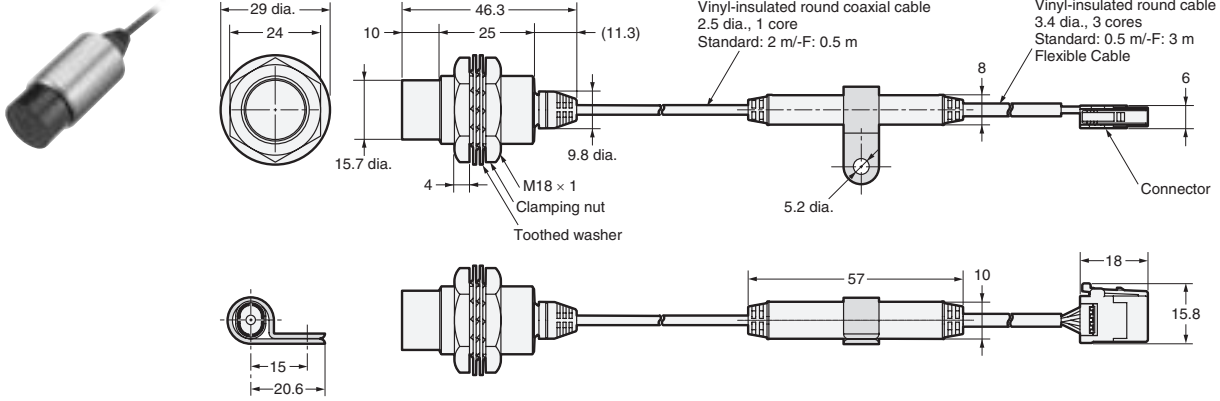

E2C-EV05(-F)

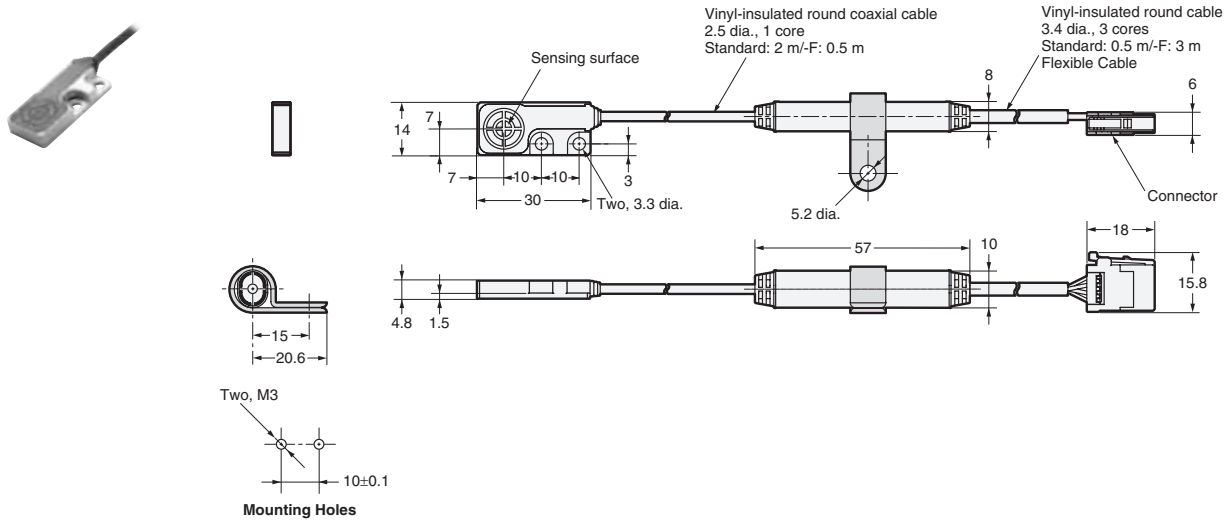

E2C-EM02H

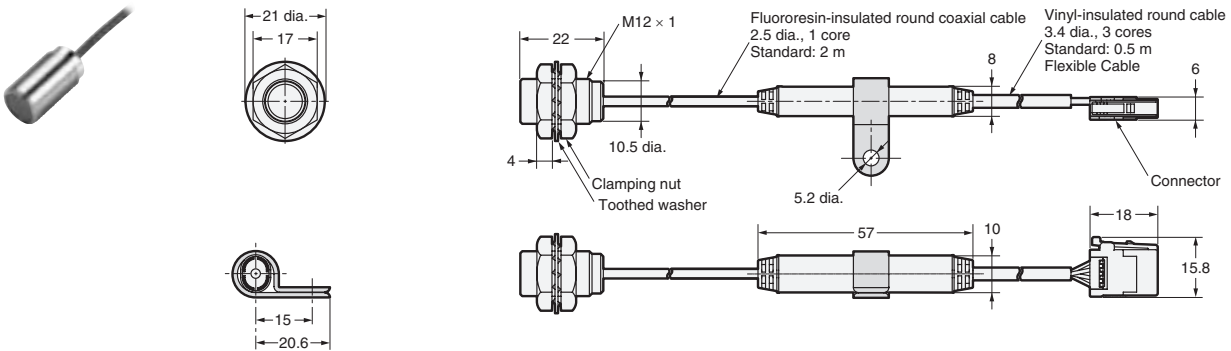

Amplifier Units

Amplifier Units with Cables

E2C-EDA11
E2C-EDA21
E2C-EDA41
E2C-EDA51

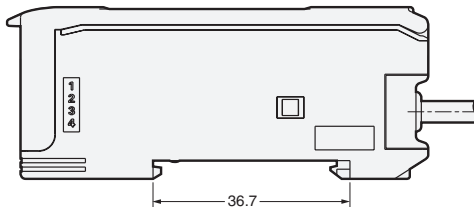
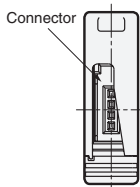
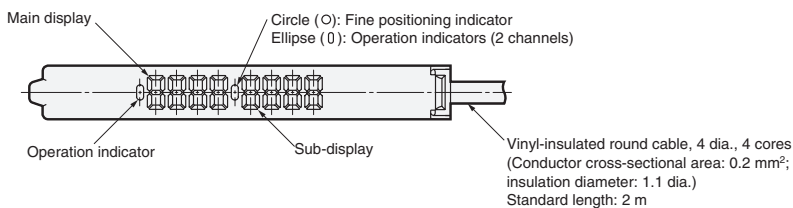

With Mounting Bracket Attached

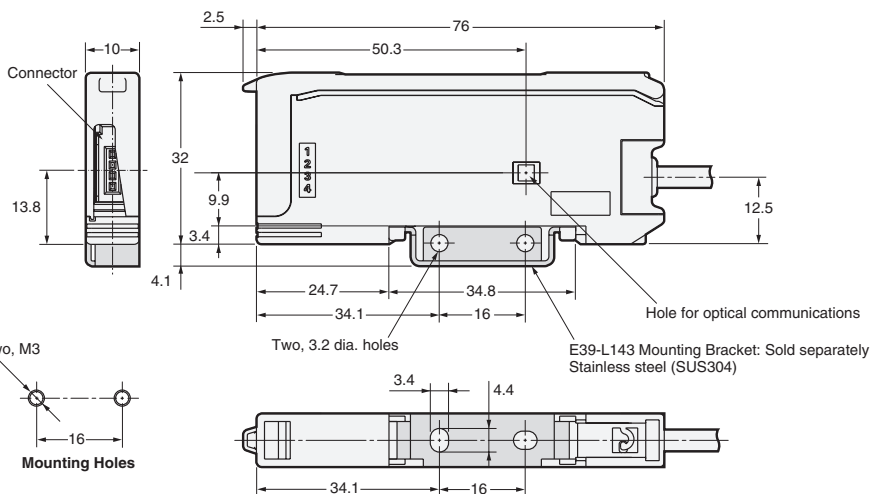
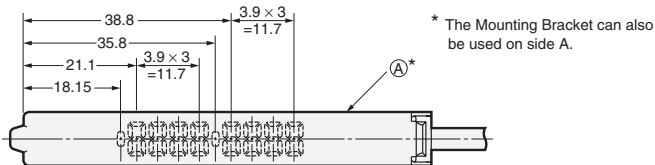

Amplifier Units with Connectors

E2C-EDA6
E2C-EDA7
E2C-EDA8
E2C-EDA9

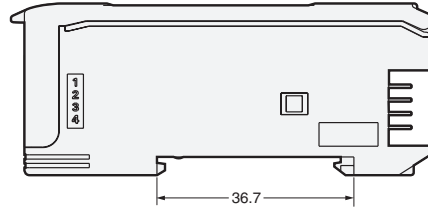
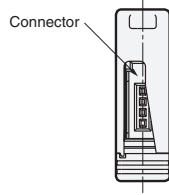
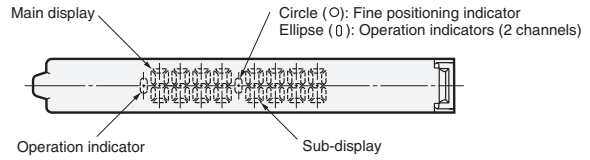

With Mounting Bracket Attached

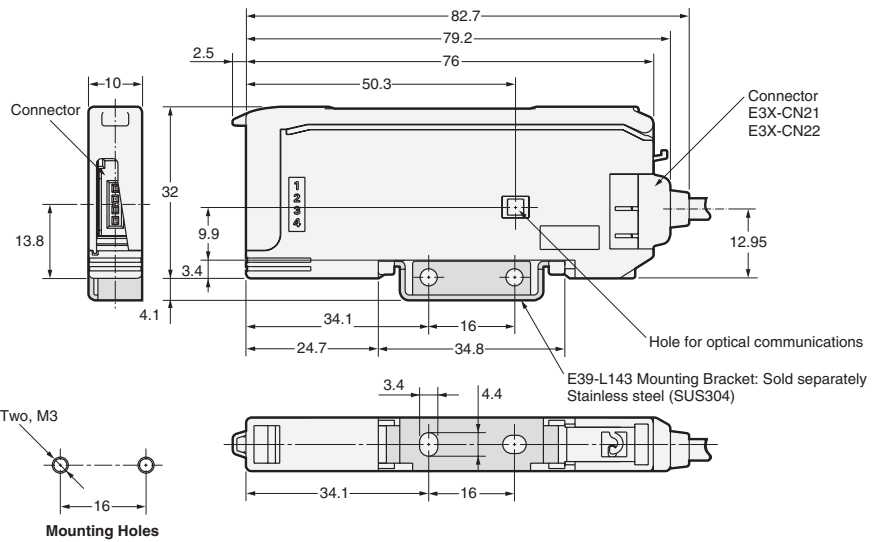
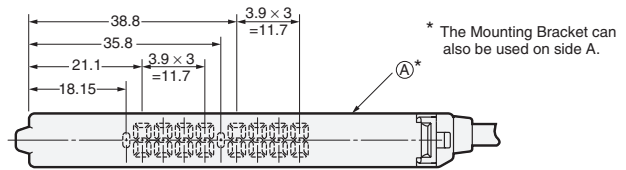

READ AND UNDERSTAND THIS DOCUMENT

Please read and understand this document before using the products. Please consult your OMRON representative if you have any questions or comments.

WARRANTY

OMRON's exclusive warranty is that the products are free from defects in materials and workmanship for a period of one year (or other period if specified) from date of sale by OMRON.

OMRON MAKES NO WARRANTY OR REPRESENTATION, EXPRESS OR IMPLIED, REGARDING NON-INFRINGEMENT, MERCHANTABILITY, OR FITNESS FOR PARTICULAR PURPOSE OF THE PRODUCTS. ANY BUYER OR USER ACKNOWLEDGES THAT THE BUYER OR USER ALONE HAS DETERMINED THAT THE PRODUCTS WILL SUITABLY MEET THE REQUIREMENTS OF THEIR INTENDED USE. OMRON DISCLAIMS ALL OTHER WARRANTIES, EXPRESS OR IMPLIED.

LIMITATIONS OF LIABILITY

OMRON SHALL NOT BE RESPONSIBLE FOR SPECIAL, INDIRECT, OR CONSEQUENTIAL DAMAGES, LOSS OF PROFITS OR COMMERCIAL LOSS IN ANY WAY CONNECTED WITH THE PRODUCTS, WHETHER SUCH CLAIM IS BASED ON CONTRACT, WARRANTY, NEGLIGENCE, OR STRICT LIABILITY.

In no event shall responsibility of OMRON for any act exceed the individual price of the product on which liability is asserted.

IN NO EVENT SHALL OMRON BE RESPONSIBLE FOR WARRANTY, REPAIR, OR OTHER CLAIMS REGARDING THE PRODUCTS UNLESS OMRON'S ANALYSIS CONFIRMS THAT THE PRODUCTS WERE PROPERLY HANDLED, STORED, INSTALLED, AND MAINTAINED AND NOT SUBJECT TO CONTAMINATION, ABUSE, MISUSE, OR INAPPROPRIATE MODIFICATION OR REPAIR.

SUITABILITY FOR USE

THE PRODUCTS CONTAINED IN THIS DOCUMENT ARE NOT SAFETY RATED. THEY ARE NOT DESIGNED OR RATED FOR ENSURING SAFETY OF PERSONS, AND SHOULD NOT BE RELIED UPON AS A SAFETY COMPONENT OR PROTECTIVE DEVICE FOR SUCH PURPOSES. Please refer to separate catalogs for OMRON's safety rated products.

OMRON shall not be responsible for conformity with any standards, codes, or regulations that apply to the combination of products in the customer's application or use of the product.

At the customer's request, OMRON will provide applicable third party certification documents identifying ratings and limitations of use that apply to the products. This information by itself is not sufficient for a complete determination of the suitability of the products in combination with the end product, machine, system, or other application or use.

The following are some examples of applications for which particular attention must be given. This is not intended to be an exhaustive list of all possible uses of the products, nor is it intended to imply that the uses listed may be suitable for the products:

- Outdoor use, uses involving potential chemical contamination or electrical interference, or conditions or uses not described in this document.
- Nuclear energy control systems, combustion systems, railroad systems, aviation systems, medical equipment, amusement machines, vehicles, safety equipment, and installations subject to separate industry or government regulations.
- Systems, machines, and equipment that could present a risk to life or property.

Please know and observe all prohibitions of use applicable to the products.

NEVER USE THE PRODUCTS FOR AN APPLICATION INVOLVING SERIOUS RISK TO LIFE OR PROPERTY WITHOUT ENSURING THAT THE SYSTEM AS A WHOLE HAS BEEN DESIGNED TO ADDRESS THE RISKS, AND THAT THE OMRON PRODUCT IS PROPERLY RATED AND INSTALLED FOR THE INTENDED USE WITHIN THE OVERALL EQUIPMENT OR SYSTEM.

PERFORMANCE DATA

Performance data given in this document is provided as a guide for the user in determining suitability and does not constitute a warranty. It may represent the result of OMRON's test conditions, and the users must correlate it to actual application requirements. Actual performance is subject to the OMRON Warranty and Limitations of Liability.

CHANGE IN SPECIFICATIONS

Product specifications and accessories may be changed at any time based on improvements and other reasons.

It is our practice to change model numbers when published ratings or features are changed, or when significant construction changes are made. However, some specifications of the product may be changed without any notice. When in doubt, special model numbers may be assigned to fix or establish key specifications for your application on your request. Please consult with your OMRON representative at any time to confirm actual specifications of purchased products.

DIMENSIONS AND WEIGHTS

Dimensions and weights are nominal and are not to be used for manufacturing purposes, even when tolerances are shown.

ERRORS AND OMISSIONS

The information in this document has been carefully checked and is believed to be accurate; however, no responsibility is assumed for clerical, typographical, or proofreading errors, or omissions.

PROGRAMMABLE PRODUCTS

OMRON shall not be responsible for the user's programming of a programmable product, or any consequence thereof.

COPYRIGHT AND COPY PERMISSION

This document shall not be copied for sales or promotions without permission.

This document is protected by copyright and is intended solely for use in conjunction with the product. Please notify us before copying or reproducing this document in any manner, for any other purpose. If copying or transmitting this document to another, please copy or transmit it in its entirety.

**A host of remarkable functions inside a compact body.
A complete lineup of sensor heads to
handle an even wider range of applications.
This is the platform for OMRON's sensing technology.**

Linear Platform

High-precision sensing based on laser, magnetic, and contact technologies.

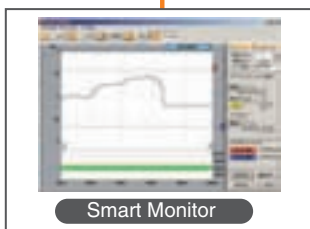

**Laser-type Smart Sensors
ZX-L Series**



An improved lineup for smarter sensing.

**Inductive Displacement
Smart Sensors
ZX-E Series**



A lineup of Smart Sensors that use the eddy current method.

**Smart Sensors:
High-precision Contact Type
ZX-T Series**



High-precision measuring that is difficult to achieve with non-contact methods.

ON/OFF Platform

A common platform for Fiber Sensors and Sensors with Separate Amplifiers.



**Digital Fiber Sensors
E3X-DA-S Series/
MDA Series**



Refinement and a new generation that goes beyond superior performance.

**Laser-type Photoelectric Sensors
with Separate Digital Amplifiers
E3C-LDA Series**



Photoelectric Sensors with Separate Digital Amplifiers have joined the Smart Sensor family.

• The application examples provided in this catalog are for reference only. Check functions and safety of the equipment before use.
• Never use the products for any application requiring special safety requirements, such as nuclear energy control systems, railroad systems, aviation systems, medical equipment, amusement machines, vehicles, safety equipment, or other application involving serious risk to life or property, without ensuring that the system as a whole has been designed to address the risks, and that the OMRON products are properly rated and installed for the intended use within the overall equipment or system.

OMRON Corporation
Industrial Automation Company
Sensing Devices Division H.Q.
Application Sensors Division
Shiokoji Horikawa, Shimogyo-ku,
Kyoto, 600-8530 Japan
Tel: (81) 75-344-7068/Fax: (81) 75-344-7107

Regional Headquarters
OMRON EUROPE B.V.
Sensor Business Unit
Carl-Benz-Str. 4, D-71154 Nufringen,
Germany
Tel: (49) 7032-811-0/Fax: (49) 7032-811-199

OMRON ELECTRONICS LLC
One Commerce Drive Schaumburg,
IL 60173-5302 U.S.A.
Tel: (1) 847-843-7900/Fax: (1) 847-843-7787

OMRON ASIA PACIFIC PTE. LTD.
No. 438A Alexandra Road # 05-05/08 (Lobby 2),
Alexandra Technopark, Singapore 119967
Tel: (65) 6835-3011/Fax: (65) 6835-2711

OMRON (CHINA) CO., LTD.
Room 2211, Bank of China Tower,
200 Yin Cheng Zhong Road,
PuDong New Area, Shanghai, 200120, China
Tel: (86) 21-5037-2222/Fax: (86) 21-5037-2200

Authorized Distributor:

In the interest of product improvement,
specifications are subject to change without notice.
CSM_1_2_0811
Cat. No. D101-E1